



Kerb markers



This stud has been exclusively designed for kerb installations such as roundabouts, islands, left turns and other bends. This effective, discreet product is perfectly suited to boosting kerb visibility in towns.

Situation

The kerb markers from GIFAS are perfect for the visual support of traffic obstructions or barriers! Such objects include:

- roundabouts/traffic islands
- Kerbs
- Filter lanes
- Edges and/or bends with a tight radius

Caractéristiques

The kerb marker is a simple and efficient instrument for effective marking at night or in the rain. Furthermore, the use of markers has an additional very interesting effect: slight repetitive vibrations can be felt when driving over these markers. These warn the driver and prevent head-on collisions and unintentional lane deviations.

- omnidirectional retro-reflection
- shape suits all kerb types (max.slope 40°)
- tempered glass for a long product life and stable lighting efficiency over time
- different colours available

Dimensions

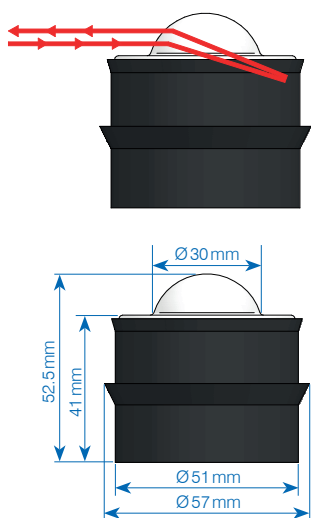

Principle

The kerb marker itself can withstand a pressure of more than 10 tons. When installed correctly, the marker does not touch the ground, and no excessive weight is applied to the glass.

Core hole 1 (47×60 mm)  
Core hole 2 (52×40 mm)

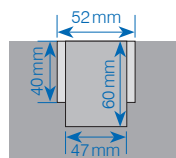

Kerb marker inserted

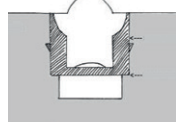

with a vehicle passing over

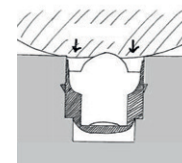

## Installation

The kerb markers are supplied in a special rubber joint. The visual appearance enables the marker to be used in any kerb, no matter what the profile looks like (also irrespective of the material).

The kerb markers can be mounted in two ways:

- on the top flat part of the kerb
- on the sloping part of the kerb

The hole for the marker is drilled perpendicular to the locating surface with a diamond core drill (a specially developed Holotool).

### 1. step

Use a core hole machine (Ø52 mm) to drill the hole



### 2. step

The core be can easily detached with a light tap on the screwdriver tip.



### 3. step

Lift the core out of the hole.

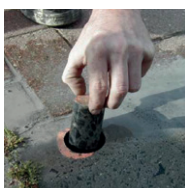

### 4. step

Place the marker directly over the core hole



### 5. step

Use a plastic hammer to knock the bolt in as far as it will go.



## Installation material

It is possible to drill a core hole with a diameter of 47 mm up to a depth of approx. 60 mm first and then drill a 2nd hole with a diameter of 52 mm and a depth of exactly 40 mm.

However, the drilling process is easier and more efficient with the Holotool. This drill consists of 2 parts, a 47 mm drill bit and a 52 mm drill bit, as well as a collar, which guarantees the requisite depth of exactly 40 mm. As a result, a core hole can be drilled with maximum efficiency. Errors in the drill holes or excessively deep or oversized holes are avoided.

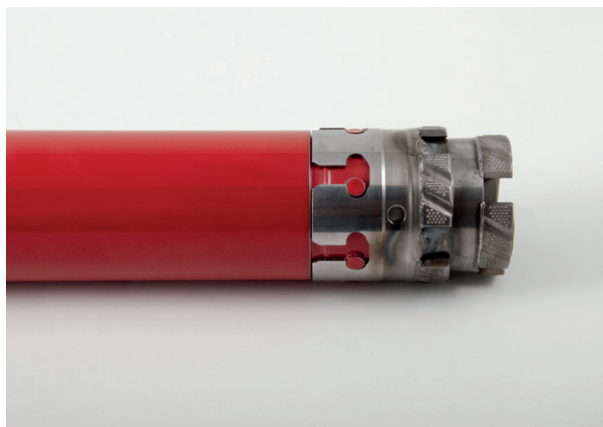
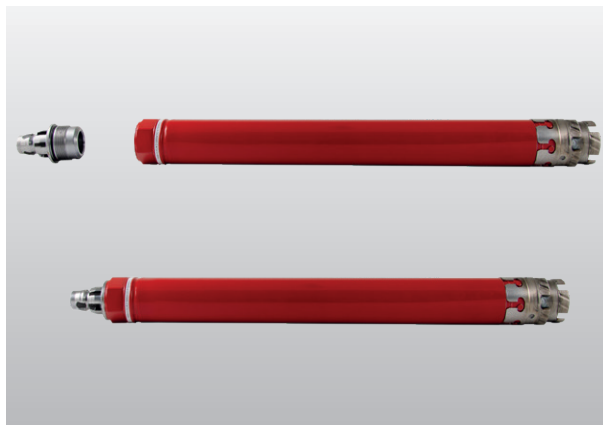

Item no.	Designation
✓ 860656	Kerb marker white
✓ *196448	Staggered drill bit Ø52 mm (Hilti)

\* Suitable for change pipe BI 52 (Hilti)

✓ from stock, offer subject to prior sale

2/2